

# FB120D

Discover the pleasure of performance



- Max. Permitted weight 16 000 kg
- Maximum loading length 4,9 m
- Crane with a maximum reach of 9,4 m

# Trailer FB120D

FTG Källefäll forest trailer FB120D has a loading capacity of 12 000 kg and a permissible total weight of 16 000 kg.

FB120D is a forestry trailer with a crane range from 6.9 m to 9.4 m of reach. It is suitable for transporting timber, firewood, pulpwood and other logs.

FB120D trailer has a double beam frame, straight drawbar with rotating towing eye  $\varnothing$  50 mm, drawbar steering with 2 hydraulic cylinders, stable protective gates, hydraulic flap-down support legs with blocking valve, boogie axle, air brakes on 4 wheels with internal brake cylinders, 4 bunks with 8 stakes, welded on sling loops for tension belt, stake holders for log bundles, foldable LED rear lighting with license plate lights,

wheels 500/50-17 with traction profile and valve protection. FB120D trailer can also be equipped with a 2-wheel drive (Black Bruin, B250 hub motors) on the rear axle and its own oil supply for optimum traction.

To meet the specific needs of each user and to expand the areas of use, FB120D trailers have a wide range of options and accessories.

FB120D combined with FTG Källefäll forestry crane offers high reliability and efficiency.

## Suitable cranes:

- [FB73T](#) - [Mv78T](#)
- [M69T](#) - [Mv94T](#)
- [M75T](#) - [P82T](#)

## Technical characteristics

### Trailer with standard equipment

<i>Parameter</i>	<i>FB120D</i>	<i>Parameter</i>	<i>FB120D</i>
Permitted weight*, kg	16 000	Wheels	500/50-17
Loading capacity, kg	12 000	Hydr. drawbar steering	2 cylinder
Load area, m <sup>2</sup>	2,45	Hydr. support legs	Flap-down
Weight*, kg	2 700	Bunks	4
Load length, m	4	Stakes	8
Frame, mm	200x100	WD system	Optional

\* Weights may vary depending on the equipment and brakes

## Technical drawings

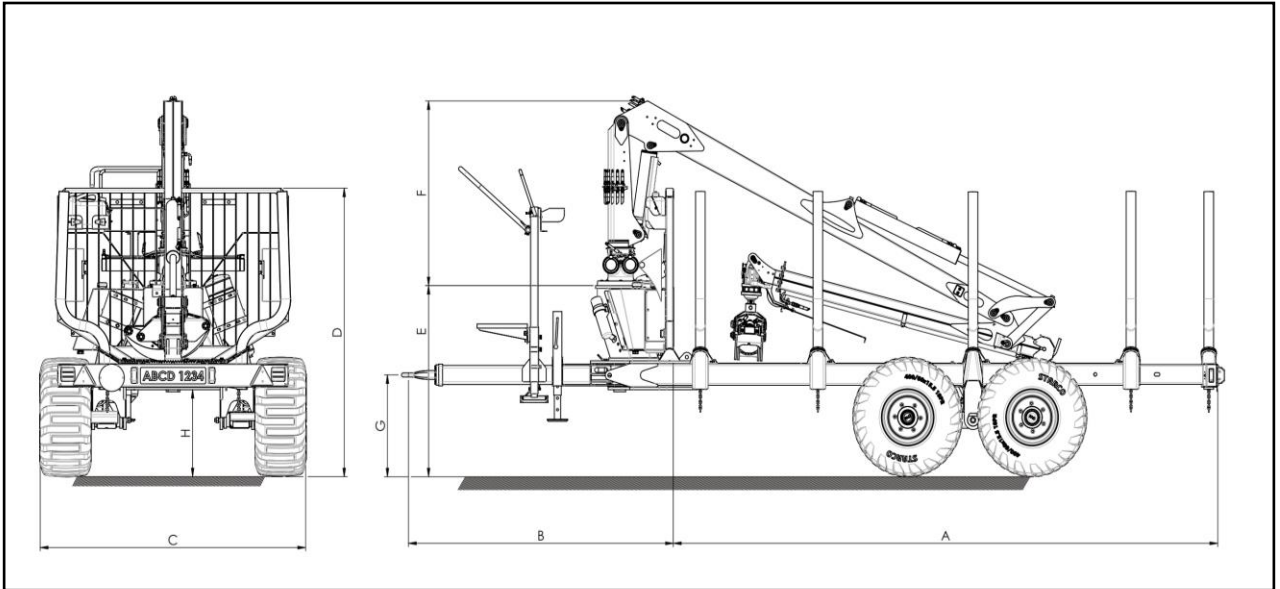

Trailer	Crane	Wheels	A	B	C	D	E	F	G	H
	FB73T	500/50-17	4165-5060	2360-2420	2635	2455	1585	1926	745-802	700
	M69T		4165-5060	2360-2420	2635	2455	1585	1580	745-802	700
FB120D /	M75T		4165-5060	2360-2420	2635	2455	1585	1750	745-802	700
FB120D-2WD	Mv78T		4165-5060	2360-2420	2635	2455	1585	1850	745-802	700
	Mv94T		4165-5060	2360-2420	2635	2455	1585	1850	745-802	700
	P82T		4165-5060	2360-2420	2635	2455	1585	2000	745-802	700

\* Dimensions may vary depending on the equipment

### Brake system options

- Hydraulic brakes
- Air brakes
- Air brakes 40 km/h approved













### Drawbar options

- Downwards
- Straight
- Upwards





## FB120D accessories

Independent hydraulic system		Frame extension		Stake extension	
Operators platform		Operators platform with ladder		Operators platform with seat	
Insert plates		Plywood floor lining		Height adjustable parking leg	
Fuel tank holder with tank		Wheel support set		Wheels 550/45-22.5 Traction profile	
Wheels 600/50-22.5 Traction profile					



### FTG BALTIC UAB

Dūmų st. 3 K20  
LT-11119 Vilnius, Lithuania  
+370 5 246 23 18  
[sales.vilnius@ftgforest.com](mailto:sales.vilnius@ftgforest.com)

For more information: [www.ftgforest.com](http://www.ftgforest.com)

By combining our Swedish heritage with constant innovation based on the needs of customers, we design forest trailers and cranes that impress by their consistently pleasant performance.

FTG Källefäll forest trailers can pass through challenging terrains and are robustly built to withstand tough grips in the forest. Trailers' capacity varies from 3 to 12 tones. Our trailers can be supplemented with telescopic cranes, ranging from 4,2 to 9,4 meters reach. Källefäll cranes are strong, fast, and easy to operate. We also offer a wide range of timber grapples and other accessories to meet different needs.