

FB50

Discover the pleasure of performance



- Max. Permitted weight 6 300 kg
- Maximum loading length 3,4 m
- Crane with a maximum reach of 4,7 m

Trailer FB50

FTG Källefäll forest trailer FB50 has a loading capacity of 5 000 kg and a permissible total weight of 6 300 kg.

FB50 is a compact forestry trailer with a crane range from 4.2m to 4.7m of reach. It is suitable for transporting firewood, pulpwood and other logs.

FB50 trailer has a single beam frame, bogie axle, stable protective gates, rigid drawbar without steering, flap-down supports legs, eyelets for tension belt, 2 pairs of bunks with 4 stakes and tires 11.5/80-15.3 with grooved profile and valve protection.

To meet the specific needs of each user and to expand the areas of use, FB50 trailers have a wide range of options and accessories.

FB50 combined with FTG Källefäll forestry crane offers high reliability and efficiency.

Suitable cranes:

- [FB42L](#)
- [FB47L](#)

Technical characteristics

Trailer with standard equipment

<i>Parameter</i>	<i>FB50</i>	<i>Parameter</i>	<i>FB50</i>
Permitted weight*, kg	6 300	Wheels	11.5/80-15.3
Loading capacity, kg	5 000	Hydr. drawbar steering	-
Load area, m ²	1,4	Hydr. support legs	Flap-down
Weight*, kg	820	Bunks	2
Load length, m	2,9	Stakes	4
Frame, mm	120x120		

* Weights may vary depending on the equipment and brakes

Technical drawings

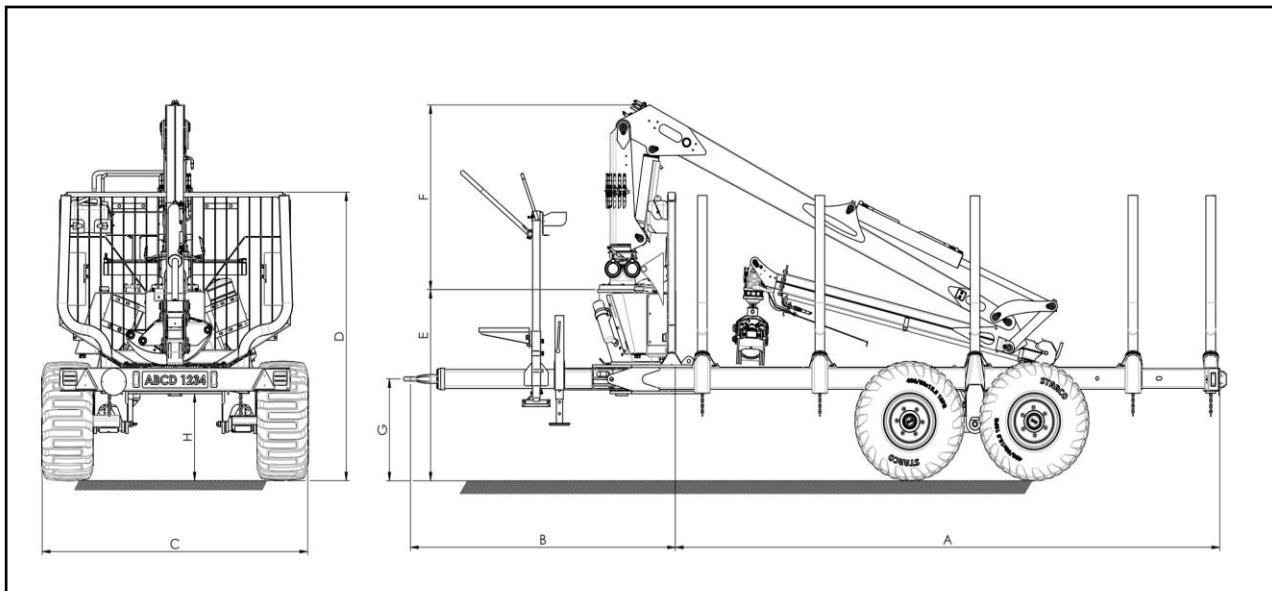



















<i>Trailer</i>	<i>Crane</i>	<i>Wheels</i>	<i>A</i>	<i>B</i>	<i>C</i>	<i>D</i>	<i>E</i>	<i>F</i>	<i>G</i>	<i>H</i>
FB50	FB42L	11.5/80-15.3	2985-3485	1785-1860	1810	1770	1182	1220	448-815	530
	FB47L		2985-3485	1785-1860	1810	1770	1182	1280	448-815	530

* Dimensions may vary depending on the equipment



FB50 accessories

Independent hydraulic system		Toolbox with cover		Center beam protection	
Operators platform		Operators platform with ladder		Operators platform with seat	
Parking leg		Parking wheel		Height adjustable parking leg	
Protective plates for support legs		Fuel tank holder with tank		Wheel support set	
Bunk with stakes		Frame extension		Foldable rear lights	
Stake connection		Block valve for telescopic support legs		Insert plates	

Brake system options

- Hydraulic
- Overrun
- Overrun with hydraulic
- Air brakes

Drawbar options

- Straight
- Upwards



FTG BALTIC UAB

Dūmų st. 3 K20
LT-11119 Vilnius, Lithuania
+370 5 246 23 18
sales.vilnius@ftgforest.com

For more information: www.ftgforest.com

By combining our Swedish heritage with constant innovation based on the needs of customers, we design forest trailers and cranes that impress by their consistently pleasant performance.

FTG Källefäll forest trailers can pass through challenging terrains and are robustly built to withstand tough grips in the forest. Trailers' capacity varies from 3 to 12 tones. Our trailers can be supplemented with telescopic cranes, ranging from 4,2 to 9,4 meters reach. Källefäll cranes are strong, fast, and easy to operate. We also offer a wide range of timber grapples and other accessories to meet different needs.