

FB90

Discover the pleasure of performance



- Max. Permitted weight 11 300 kg
- Maximum loading length 4,3 m
- Crane with a maximum reach of 7,5 m

Trailer FB90

FTG Källefäll forest trailer FB90 has a loading capacity of 9 000 kg and a permissible total weight of 11 300 kg.

FB90 is a forestry trailer with a crane range from 5.1 m to 7.5 m of reach. It is suitable for transporting timber, firewood, pulpwood and other logs.

FB90 trailer has a single beam frame, straight drawbar with rotating towing eye Ø 50 mm, drawbar steering with 2 hydraulic cylinders, stable protective gates, hydraulic telescopic support legs, boogie axle, 3 bunks with 6 stakes, toolboxes, wheels 400/60-15.5. FB90 trailer can also be equipped with a 2-wheel drive (Black Bruin, B240 hub motors) on the rear axle and its own oil supply for

optimum traction.

To meet the specific needs of each user and to expand the areas of use, FB90 trailers have a wide range of options and accessories.

FB90 combined with FTG Källefäll forestry crane offers high reliability and efficiency.

Suitable cranes:

- [FB51L](#) - [FB69T](#) - [P75T](#)
- [FB63T](#) - [P65](#) - [M65T](#)
- [FB63TS](#) - [P67T](#) - [M69T](#)

Technical characteristics

Trailer with standard equipment

| <i>Parameter</i> | <i>FB90</i> | <i>Parameter</i> | <i>FB90</i> |
|---------------------------|-------------|------------------------|-------------|
| Permitted weight*, kg | 11 300 | Wheels | 400/60-15.5 |
| Loading capacity, kg | 9 000 | Hydr. drawbar steering | 2 cylinder |
| Load area, m ² | 2 | Hydr. support legs | Teleskopic |
| Weight,*, kg | 1 600 | Bunks | 3 |
| Load length, m | 3,7 | Stakes | 6 |
| Frame, mm | 160x160 | WD system | Optional |

* Weights may vary depending on the equipment and brakes

Technical drawings

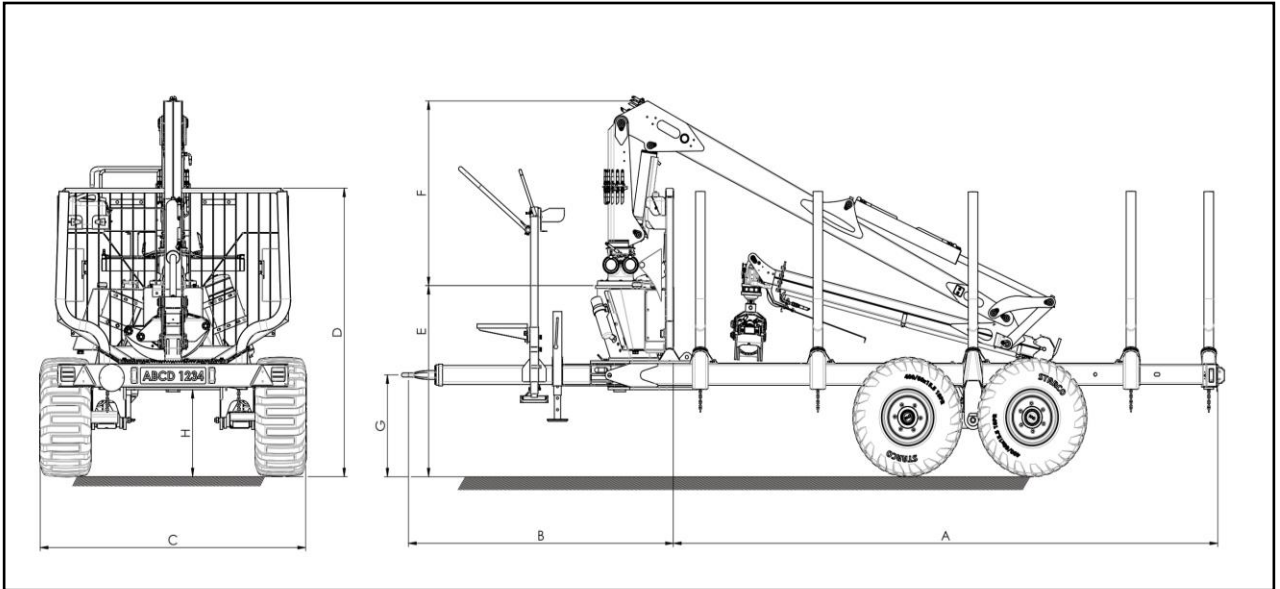

| <i>Trailer</i> | <i>Crane</i> | <i>Wheels</i> | <i>A</i> | <i>B</i> | <i>C</i> | <i>D</i> | <i>E</i> | <i>F</i> | <i>G</i> | <i>H</i> |
|----------------|--------------|---------------|-----------|-----------|----------|----------|----------|----------|----------|----------|
| | FB51L | 400/60-15.5 | 3865-4465 | 2000-2620 | 2040 | 2175 | 1400 | 1490 | 386-959 | 640 |
| | FB63T | | 3865-4465 | 2000-2620 | 2040 | 2175 | 1400 | 1370 | 386-959 | 640 |
| | FB63TS | | 3865-4465 | 2000-2620 | 2040 | 2175 | 1400 | 1370 | 386-959 | 640 |
| FB90 / | FB69T | | 3865-4465 | 2000-2620 | 2040 | 2175 | 1400 | 1370 | 386-959 | 640 |
| FB90-2WD | P65 | | 3865-4465 | 2000-2620 | 2040 | 2175 | 1400 | 2000 | 386-959 | 640 |
| | P67T | | 3865-4465 | 2000-2620 | 2040 | 2175 | 1400 | 1800 | 386-959 | 640 |
| | P75T | | 3865-4465 | 2000-2620 | 2040 | 2175 | 1400 | 2000 | 386-959 | 640 |
| | M65T | | 3865-4465 | 2000-2620 | 2040 | 2175 | 1400 | 1540 | 386-959 | 640 |
| | M69T | | 3865-4465 | 2000-2620 | 2040 | 2175 | 1400 | 1580 | 386-959 | 640 |

* Dimensions may vary depending on the equipment





















Brake system options

- Hydraulic brakes
- Overrun brakes
- Overrun and hydraulic brakes
- Air brakes
- Air brakes 40 km/h approved

Drawbar options

- Downwards
- Straight
- Upwards

FB90 accessories

| | | | | | |
|---|---|-----------------------------------|---|---|---|
| Independent hydraulic system |  | Toolbox cover |  | Center beam protection |  |
| Block valve for telescopic support legs |  | Operators platform with ladder |  | Operators platform with seat |  |
| Parking leg |  | Parking wheel |  | Height adjustable parking leg |  |
| Protective plates for support legs |  | Fuel tank holder with tank |  | Wheel support set |  |
| Stake holder for 1 meter wood |  | Frame extension |  | Registration plate plate light protection bar |  |
| Insert plates |  | Stake connection |  | Stake extension |  |
| Wheels 400/60-15.5 Traction profile |  | Wheels 480/45-17 Traction profile |  | Wheels 500/50-17 Traction profile |  |



FTG BALTIC UAB

Dūmų st. 3 K20
 LT-11119 Vilnius, Lithuania
 +370 5 246 23 18
sales.vilnius@ftgforest.com

For more information: www.ftgforest.com

By combining our Swedish heritage with constant innovation based on the needs of customers, we design forest trailers and cranes that impress by their consistently pleasant performance.

FTG Källefäll forest trailers can pass through challenging terrains and are robustly built to withstand tough grips in the forest. Trailers' capacity varies from 3 to 12 tones. Our trailers can be supplemented with telescopic cranes, ranging from 4,2 to 9,4 meters reach. Källefäll cranes are strong, fast, and easy to operate. We also offer a wide range of timber grapples and other accessories to meet different needs.