

FB100

Discover the pleasure of performance



- Max. Permitted weight 13 000 kg
- Maximum loading length 4,5 m
- Crane with a maximum reach of 7,5 m

Trailer B100

FTG Källefäll forest trailer FB100 has a loading capacity of 10 000 kg and a permissible total weight of 13 000 kg.

FB100 is a forestry trailer with a crane range from 6.3 m to 7.5 m of reach. It is suitable for transporting timber, firewood, pulpwood and other logs.

FB100 trailer has a single beam frame with movable frame extension, straight drawbar with rotating towing eye Ø 50 mm, drawbar steering with 2 hydraulic cylinders, stable protective gates, hydraulic telescopic support legs, boogie axle, 3 bunks with 6 stakes, toolboxes, integrated LED rear lighting with license plate lights, wheels 400/60-15.5. FB100 trailer can also be

equipped with a 2-wheel drive (Black Bruin, B250 hub motors) on the rear axle and its own oil supply for optimum traction.

To meet the specific needs of each user and to expand the areas of use, FB100 trailers have a wide range of options and accessories.

FB100 combined with FTG Källefäll forestry crane offers high reliability and efficiency.

Suitable cranes:

- [FB63T](#) - [M69T](#)
- [FB63TS](#) - [M75T](#)
- [FB69T](#) - [P75T](#)

Technical characteristics

Trailer with standard equipment

<i>Parameter</i>	<i>FB100</i>	<i>Parameter</i>	<i>FB100</i>
Permitted weight*, kg	13 000	Wheels	400/60-15.5
Loading capacity, kg	10 000	Hydr. drawbar steering	2 cylinder
Load area, m ²	2,2	Hydr. support legs	Telescopic
Weight,*, kg	1 700	Bunks	4
Load length, m	3,9-4,5	Stakes	8
Frame, mm	160x160	WD system	Optional

* Weights may vary depending on the equipment and brakes

Technical drawings

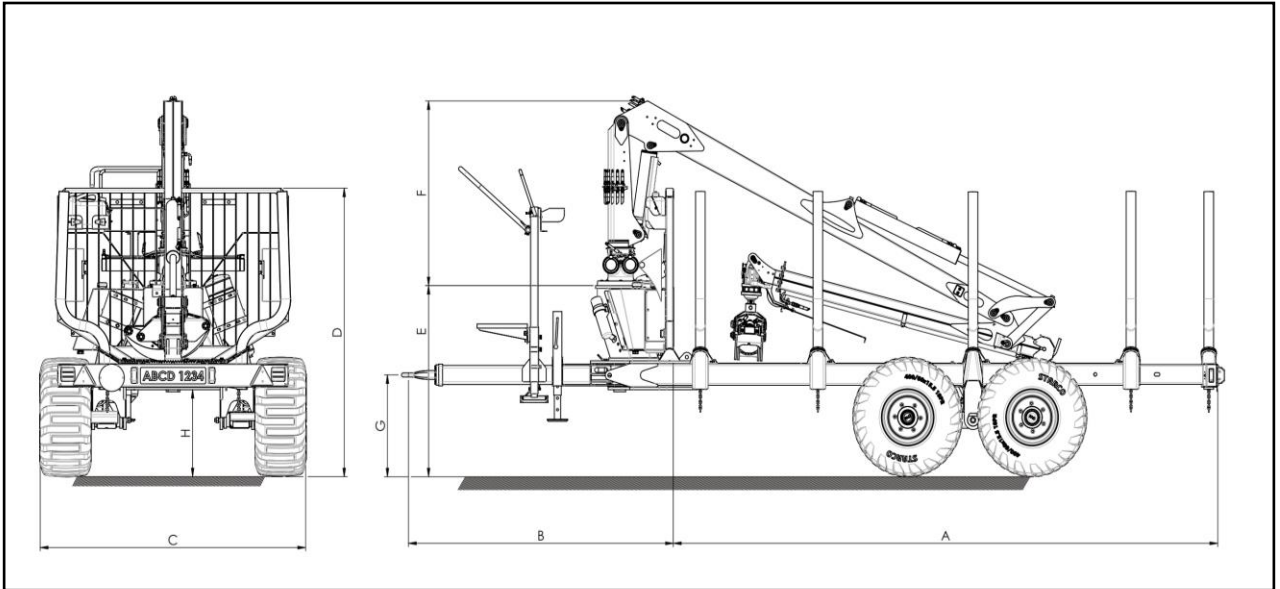

Trailer	Crane	Wheels	A	B	C	D	E	F	G	H
	FB63T	500/50-17	3955-4580	1175-2035	2330	2200	1345	1370	454-946	625
	FB63TS		3955-4580	1175-2035	2330	2200	1345	1370	454-946	625
FB100 /	FB69T		3955-4580	1175-2035	2330	2200	1345	1370	454-946	625
FB100-2WD	M69T		3955-4580	1175-2035	2330	2200	1345	1580	454-946	625
	M75T		3955-4580	1175-2035	2330	2200	1345	1800	454-946	625
	P75T		3955-4580	1175-2035	2330	2200	1345	2000	454-946	625

* Dimensions may vary depending on the equipment

Brake system options















- Hydraulic brakes
- Air brakes
- Air brakes 40 km/h approved

Drawbar options

- Downwards
- Straight
- Upwards



FB100 accessories

<p>Independent hydraulic system</p>		<p>Block valve for telescopic support legs</p>		<p>Stake extension</p>	
<p>Insert plates</p>		<p>Operators platform</p>		<p>Operators platform with seat</p>	
<p>Parking leg</p>		<p>Parking wheel</p>		<p>Height adjustable parking leg</p>	
<p>Protective plates for support legs</p>		<p>Fuel tank holder with tank</p>		<p>Wheel support set</p>	
<p>Wheels 500/50-17 Traction profile</p>		<p>Wheels 500/45-22.5 Traction profile</p>		<p>Wheels 550/45-22.5 Traction profile</p>	



FTG BALTIC UAB

Dūmų st. 3 K20
 LT-11119 Vilnius, Lithuania
 +370 5 246 23 18
sales.vilnius@ftgforest.com

For more information: www.ftgforest.com

By combining our Swedish heritage with constant innovation based on the needs of customers, we design forest trailers and cranes that impress by their consistently pleasant performance.

FTG Källefäll forest trailers can pass through challenging terrains and are robustly built to withstand tough grips in the forest. Trailers' capacity varies from 2,5 to 12 tones. Our trailers can be supplemented with telescopic cranes, ranging from 4,2 to 9,4 meters reach. Källefäll cranes are strong, fast, and easy to operate. We also offer a wide range of timber grapples and other accessories to meet different needs.