

# FB40D

Discover the pleasure of performance



- Max. Permitted weight 6 000 kg
- Maximum loading length 3,6 m
- Crane with a maximum reach of 5,3 m

# Trailer FB40D

FTG Källefäll trailer FB40D provides a loading capacity up to 4000kg and a permissible total weight of 6 000 kg.

FB40D is a compact one axle timber trailer with a crane selection from 4,2m up to 5,3m of reach. It is suitable for the transportation of firewood, pulpwood, and other timber logs.

Standard trailer FB40D has a double beam frame, fixed straight drawbar, solid crane base with hydraulic telescopic support legs, sling loops for tension belt, integrated LED lights, and plate number lights, fixed 4 bunks with 8 stakes, and 12.5/80–15.3 wheels.

To suit every users' specific needs and extend the areas of use FB40D trailers have a broad range of options and accessories.

FB40D combined with FTG Källefäll forest cranes offers high reliability and efficiency. Demand for maintenance is quite low for high-quality components and tested designs

## Suitable cranes:

- [FB42L](#)
- [FB47L](#)
- [FB51](#)
- [FB53T](#)

## Technical characteristics

### Trailer with standard equipment

<i>Parameter</i>	<i>FB40D</i>	<i>Parameter</i>	<i>FB40D</i>
Permitted weight*, kg	6 000	Wheels	12.5/80–15.3
Loading capacity, kg	4 000	Hydr. drawbar steering	-
Load area, m <sup>2</sup>	1,3	Hydr. support legs	Telescopic
Weight*, kg	1200	Bunks	4
Load length, m	3,6	Stakes	8
Frame, mm	140x180		

\* Weights may vary depending on the equipment and brakes

## Technical drawings

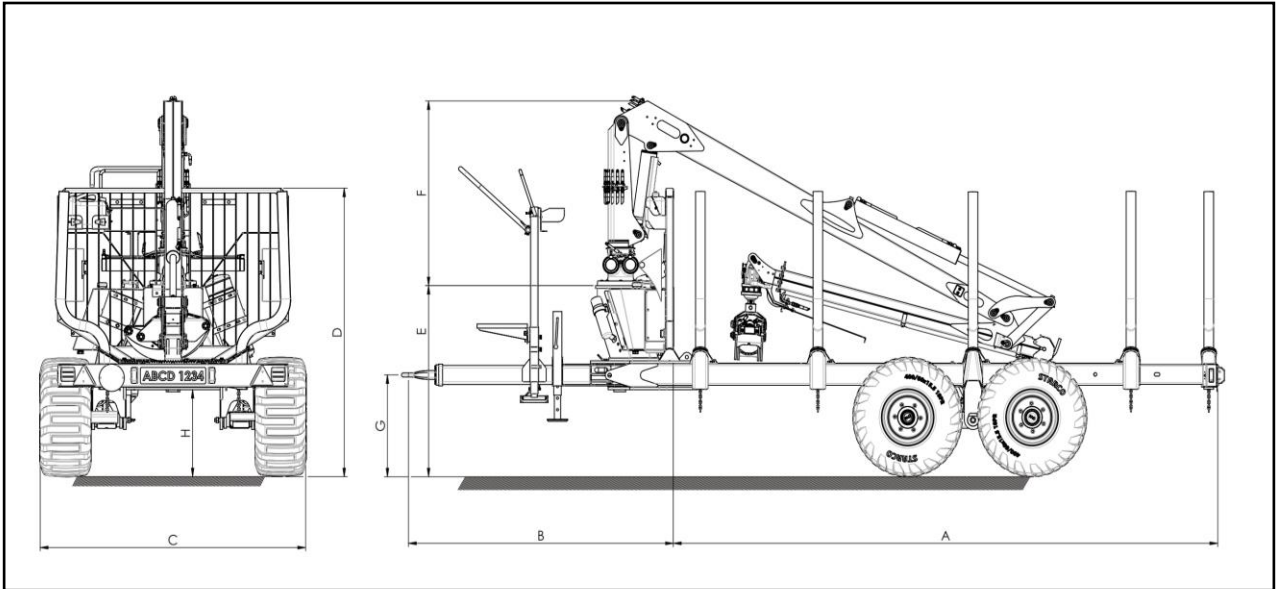















<i>Trailer</i>	<i>Crane</i>	<i>Wheels</i>	<i>A</i>	<i>B</i>	<i>C</i>	<i>D</i>	<i>E</i>	<i>F</i>	<i>G</i>	<i>H</i>
FB40D	FB42L	400/60-15.5	3660	1980	2100	1535	1050	1220	540-770	450
	FB47L		3660	1980	2100	1535	1050	1280	540-770	450
	FB51		3660	1980	2100	1535	1050	1490	540-770	450
	FB53T		3660	1980	2100	1535	1050	1280	540-770	450

\* Dimensions may vary depending on the equipment



## FB40D accessories

Independent hydraulic system		Toolbox with cover		Grapple holder	
Operators platform with ladder		Operators platform with seat		Block valve for telescopic support legs	
Parking leg		Parking wheel		Insert plates	
Shoes for telescopic support legs		Fuel tank holder with tank		Wheel support set	
Wheels 400/60-15.5 Road profile		Wheels 400/60-15.5 Traction profile			

### Brake options

- Hydraulic brakes
- Overrun brakes

### Drawbar options

- Straight drawbar
- Upwards drawbar



### FTG BALTIC UAB

Dūmų st. 3 K20  
LT-11119 Vilnius, Lithuania  
+370 5 246 23 18  
[sales.vilnius@ftgforest.com](mailto:sales.vilnius@ftgforest.com)

By combining our Swedish heritage with constant innovation based on the needs of customers, we design forest trailers and cranes that impress by their consistently pleasant performance.

FTG Källefäll forest trailers can pass through challenging terrains and are robustly built to withstand tough conditions in the forest. Trailers' capacity varies from 2,5 to 12 tones. Our trailers can be supplemented with telescopic cranes, ranging from 4,2 to 9,4 meters reach. Källefäll cranes are strong, fast, and easy to operate. We also offer a wide range of timber grapples and other accessories to meet different needs.

For more information: [www.ftgforest.com](http://www.ftgforest.com)