

FB60

Discover the pleasure of performance



- Max. Permitted weight 7 550 kg
- Maximum loading length 3,4 m
- Crane with a maximum reach of 5,3 m

Trailer FB60

FTG Källefäll forest trailer FB60 has a loading capacity of 6 000 kg and a permissible total weight of 7 550 kg.

FB60 is a compact forestry trailer with a crane range from 4.7 m to 5.3 m of reach. It is suitable for transporting firewood, pulpwood and other logs.

FB60 trailer has a single beam frame, bogie axle, stable protective gates, rigid drawbar without steering, flap-down supports legs, eyelets for tension belt, 2 pairs of bunks with 4 stakes and tires 11.5/80-15.3 with grooved profile and valve protection.

To meet the specific needs of each user and to expand the areas of use, FB60 trailers have a wide range of options and accessories.

FB60 combined with FTG Källefäll forestry crane offers high reliability and efficiency.

Suitable cranes:

- [FB47L](#)
- [FB51](#)
- [FB53T](#)

Technical characteristics

Trailer with standard equipment

<i>Parameter</i>	<i>FB60</i>	<i>Parameter</i>	<i>FB60</i>
Permitted weight*, kg	7 550	Wheels	11.5/80-15.3
Loading capacity, kg	6 000	Hydr. drawbar steering	-
Load area, m ²	1,75	Hydr. support legs	Flap-down
Weight*, kg	1 000	Bunks	2
Load length, m	2,9	Stakes	4
Frame, mm	120x120		

* Weights may vary depending on the equipment and brakes

Technical drawings

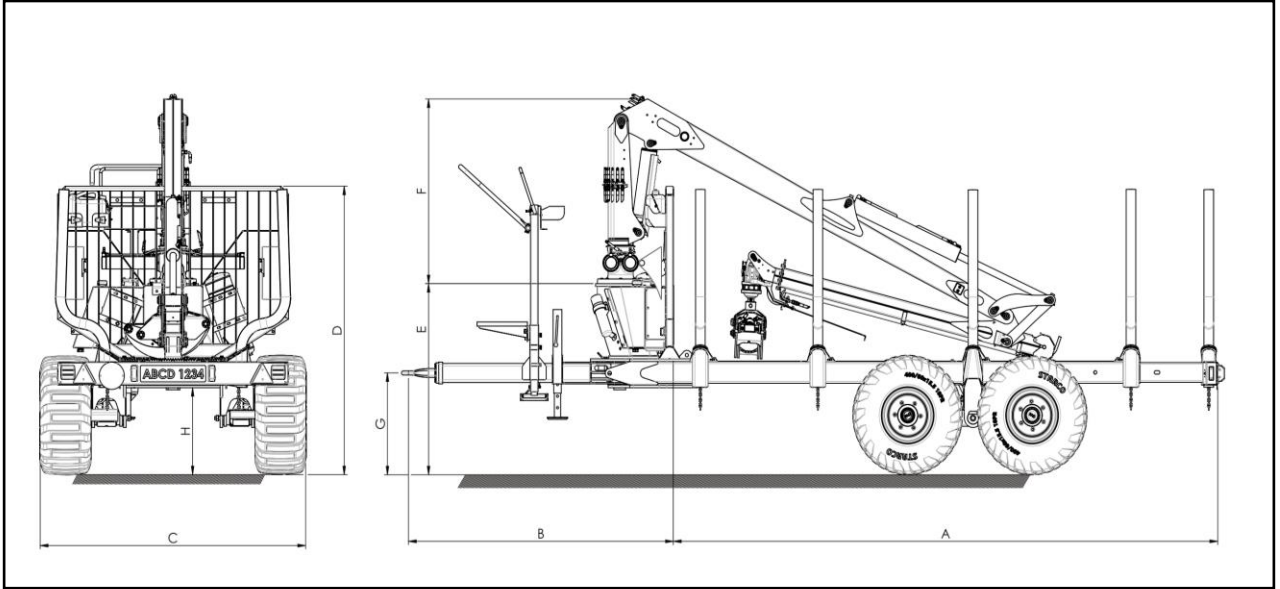

<i>Trailer</i>	<i>Crane</i>	<i>Wheels</i>	<i>A</i>	<i>B</i>	<i>C</i>	<i>D</i>	<i>E</i>	<i>F</i>	<i>G</i>	<i>H</i>
	FB47L		2985-3485	1785-1860	2010	1875	1195	1280	448-815	545
FB60	FB51	400/60-15.5	2985-3485	1785-1860	2010	1875	1195	1490	448-815	545
	FB53T		2985-3485	1785-1860	2010	1875	1195	1280	448-815	545

* Dimensions may vary depending on the equipment

Brake system options





















- Hydraulic
- Overrun
- Overrun with hydraulic
- Air brakes

Drawbar options

- Straight
- Upwards



FB60 accessories

Independent hydraulic system		Toolbox with cover		Center beam protection	
Operators platform		Operators platform with ladder		Operators platform with seat	
Parking leg		Parking wheel		Height adjustable parking leg	
Protective plates for support legs		Fuel tank holder with tank		Wheel support set	
Bunk with stakes		Frame extension		Foldable rear lights	
Stake extension		Stake connection		Block valve for telescopic support legs	
Insert plates		Wheels 400/60-15.5 Road profile		Wheels 400/60-15.5 Traction profile	



FTG BALTIC UAB

Dūmų st. 3 K20
 LT-11119 Vilnius, Lithuania
 +370 5 246 23 18
sales.vilnius@ftgforest.com

For more information: www.ftgforest.com

By combining our Swedish heritage with constant innovation based on the needs of customers, we design forest trailers and cranes that impress by their consistently pleasant performance.

FTG Källefäll forest trailers can pass through challenging terrains and are robustly built to withstand tough grips in the forest. Trailers' capacity varies from 2,5 to 12 tones. Our trailers can be supplemented with telescopic cranes, ranging from 4,2 to 9,4 meters reach. Källefäll cranes are strong, fast, and easy to operate. We also offer a wide range of timber grapples and other accessories to meet different needs.