

FB70

Discover the pleasure of performance



- Max. Permitted weight 9 000 kg
- Maximum loading length 4 m
- Crane with a maximum reach of 6,7 m

Trailer FB70

FTG Källefäll forest trailer FB70 has a loading capacity of 7 000 kg and a permissible total weight of 9 000 kg.

FB70 is a compact forestry trailer with a crane range from 5,1 m to 6.7 m of reach. It is suitable for transporting firewood, pulpwood and other logs.

FB70 trailer has a single beam frame, bogie axle, stable protective gates, drawbar with hydraulic steering, telescopic A-type supports legs, eyelets for tension belt, 2 pairs of bunks with 4 stakes and tires 11.5/80-15.3 with grooved profile and valve protection.

To meet the specific needs of each user and to expand the areas of use, FB70 trailers have a wide range of options and accessories.

FB70 combined with FTG Källefäll forestry crane offers high reliability and efficiency.

Suitable cranes:

- [FB51](#) - [P52](#) - [M65T](#)
- [FB53T](#) - [P57](#)
- [FB63T](#) - [P67T](#)

Technical characteristics

Trailer with standard equipment

<i>Parameter</i>	<i>FB70</i>	<i>Parameter</i>	<i>FB70</i>
Permitted weight*, kg	9 000	Wheels	11.5/80-15.3
Loading capacity, kg	7 000	Hydr. drawbar steering	1 cylinder
Load area, m ²	1,9	Hydr. support legs	Telescopic
Weight,*, kg	1 300	Bunks	2
Load length, m	3,7	Stakes	4
Frame, mm	140x140		

* Weights may vary depending on the equipment and brakes

Technical drawings

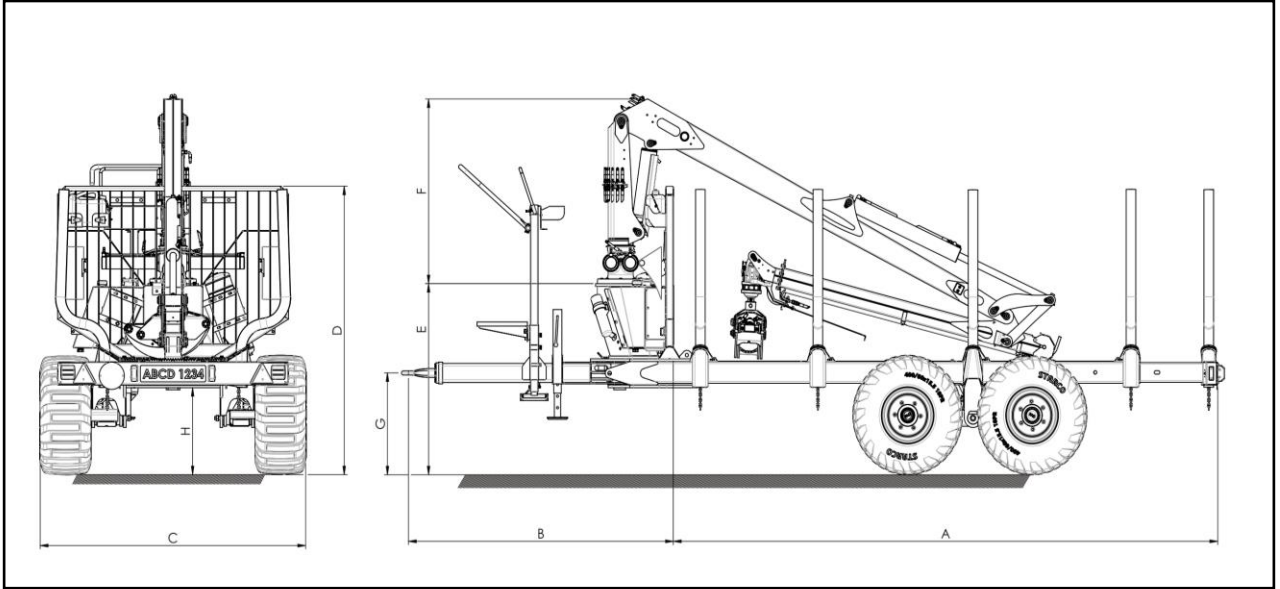

Trailer	Crane	Wheels	A	B	C	D	E	F	G	H
FB70	FB51	400/60-15.5	3865-4165	1845-2475	2035	1950	1365	1490	407-864	625
	FB53T		3865-4165	1845-2475	2035	1950	1365	1280	407-864	625
	FB63T		3865-4165	1845-2475	2035	1950	1365	1370	407-864	625
	P52		3865-4165	1845-2475	2035	1950	1365	1750	407-864	625
	P57		3865-4165	1845-2475	2035	1950	1365	1800	407-864	625
	P67T		3865-4165	1845-2475	2035	1950	1365	1800	407-864	625
	M65T		3865-4165	1845-2475	2035	1950	1365	1540	407-864	625

* Dimensions may vary depending on the equipment

Brake system options





















- Hydraulic
- Overrun
- Overrun with hydraulic
- Air brakes
- Air brakes 40km/h approved

Drawbar options

- Straight
- Upwards
- Downwards



FB70 accessories

Independent hydraulic system		Toolbox with cover		Center beam protection	
Operators platform		Operators platform with ladder		Operators platform with seat	
Parking leg		Parking wheel		Height adjustable parking leg	
Protective plates for support legs		Fuel tank holder with tank		Wheel support set	
Bunk with stakes		Frame extension		Foldable rear lights	
Stake extension		Stake connection		Block valve for telescopic support legs	
Insert plates		Wheels 400/60-15.5 Road profile		Wheels 400/60-15.5 Traction profile	



FTG BALTIC UAB

Dūmų st. 3 K20
 LT-11119 Vilnius, Litauen
 +370 5 246 23 18
sales.vilnius@ftgforest.com

Für mehr Informationen: www.ftgforest.com

Durch die Kombination unseres schwedischen Erbes mit ständiger Innovation, die sich an den Bedürfnissen der Kunden orientiert, entwickeln wir Forstanhänger und Krane, die durch ihre gleichbleibend gute Leistung überzeugen.

FTG Källefall Rückewagen können durch anspruchsvolles Gelände fahren und sind robust gebaut, um den harten Bedingungen im Wald standzuhalten. Die Ladekapazität der Anhänger variiert zwischen 2,5 und 12 Tonnen. Källefall Krane sind stark, schnell und einfach zu bedienen. Wir bieten auch eine große Auswahl an Holz-, Energieholz-, Schallengreifern und anderem Zubehör, um den unterschiedlichen Arbeitsanforderungen gerecht zu werden.