

# FB90

Discover the pleasure of performance



- Max. Permitted weight 11 300 kg
- Maximum loading length 4,3 m
- Crane with a maximum reach of 7,5 m

# Trailer FB90

FTG Källefäll forest trailer FB90 has a loading capacity of 9 000 kg and a permissible total weight of 11 300 kg.

FB90 is a forestry trailer with a crane range from 5.1 m to 7.5 m of reach. It is suitable for transporting timber, firewood, pulpwood and other logs.

FB90 trailer has a single beam frame, straight drawbar with rotating towing eye Ø 50 mm, drawbar steering with 2 hydraulic cylinders, stable protective gates, hydraulic telescopic support legs, boogie axle, 3 bunks with 6 stakes, toolboxes, wheels 400/60-15.5. FB90 trailer can also be equipped with a 2-wheel drive (Black Bruin, B240 hub motors) on the rear axle and its own oil supply for

optimum traction.

To meet the specific needs of each user and to expand the areas of use, FB90 trailers have a wide range of options and accessories.

FB90 combined with FTG Källefäll forestry crane offers high reliability and efficiency.

## Suitable cranes:

- [FB51L](#) - [FB69T](#) - [P75T](#)
- [FB63T](#) - [P65](#) - [M65T](#)
- [FB63TS](#) - [P67T](#) - [M69T](#)

## Technical characteristics

### Trailer with standard equipment

<i>Parameter</i>	<i>FB90</i>	<i>Parameter</i>	<i>FB90</i>
Permitted weight*, kg	11 300	Wheels	400/60-15.5
Loading capacity, kg	9 000	Hydr. drawbar steering	2 cylinder
Load area, m <sup>2</sup>	2	Hydr. support legs	Teleskopic
Weight,*, kg	1 600	Bunks	3
Load length, m	3,7	Stakes	6
Frame, mm	160x160	WD system	Optional

\* Weights may vary depending on the equipment and brakes

## Technical drawings

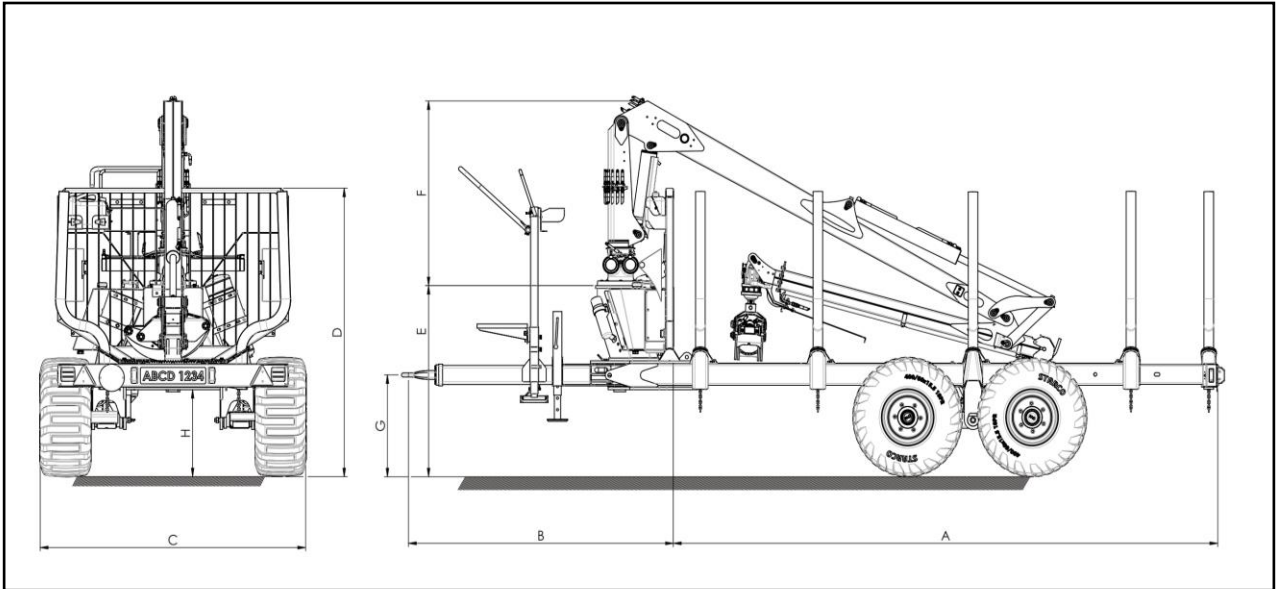

<i>Trailer</i>	<i>Crane</i>	<i>Wheels</i>	<i>A</i>	<i>B</i>	<i>C</i>	<i>D</i>	<i>E</i>	<i>F</i>	<i>G</i>	<i>H</i>
	FB51L		3865-4465	2000-2620	2040	2175	1400	1490	386-959	640
	FB63T		3865-4465	2000-2620	2040	2175	1400	1370	386-959	640
	FB63TS		3865-4465	2000-2620	2040	2175	1400	1370	386-959	640
FB90 /	FB69T	400/60-15.5	3865-4465	2000-2620	2040	2175	1400	1370	386-959	640
FB90-2WD	P65		3865-4465	2000-2620	2040	2175	1400	2000	386-959	640
	P67T		3865-4465	2000-2620	2040	2175	1400	1800	386-959	640
	P75T		3865-4465	2000-2620	2040	2175	1400	2000	386-959	640
	M65T		3865-4465	2000-2620	2040	2175	1400	1540	386-959	640
	M69T		3865-4465	2000-2620	2040	2175	1400	1580	386-959	640

\* Dimensions may vary depending on the equipment





















### Brake system options

- Hydraulic brakes
- Overrun brakes
- Overrun and hydraulic brakes
- Air brakes
- Air brakes 40 km/h approved

### Drawbar options

- Downwards
- Straight
- Upwards

## FB90 accessories

Independent hydraulic system		Toolbox cover		Center beam protection	
Block valve for telescopic support legs		Operators platform with ladder		Operators platform with seat	
Parking leg		Parking wheel		Height adjustable parking leg	
Protective plates for support legs		Fuel tank holder with tank		Wheel support set	
Stake holder for 1 meter wood		Frame extension		Registration plate plate light protection bar	
Insert plates		Stake connection		Stake extension	
Wheels 400/60-15.5 Traction profile		Wheels 480/45-17 Traction profile		Wheels 500/50-17 Traction profile	



### FTG BALTIC UAB

Dūmų st. 3 K20  
 LT-11119 Vilnius, Lithuania  
 +370 5 246 23 18  
[sales.vilnius@ftgforest.com](mailto:sales.vilnius@ftgforest.com)

For more information: [www.ftgforest.com](http://www.ftgforest.com)

By combining our Swedish heritage with constant innovation based on the needs of customers, we design forest trailers and cranes that impress by their consistently pleasant performance.

FTG Källefäll forest trailers can pass through challenging terrains and are robustly built to withstand tough grips in the forest. Trailers' capacity varies from 2,5 to 12 tones. Our trailers can be supplemented with telescopic cranes, ranging from 4,2 to 9,4 meters reach. Källefäll cranes are strong, fast, and easy to operate. We also offer a wide range of timber grapples and other accessories to meet different needs.